

Rev	Date
A	06 / 01 / 2025

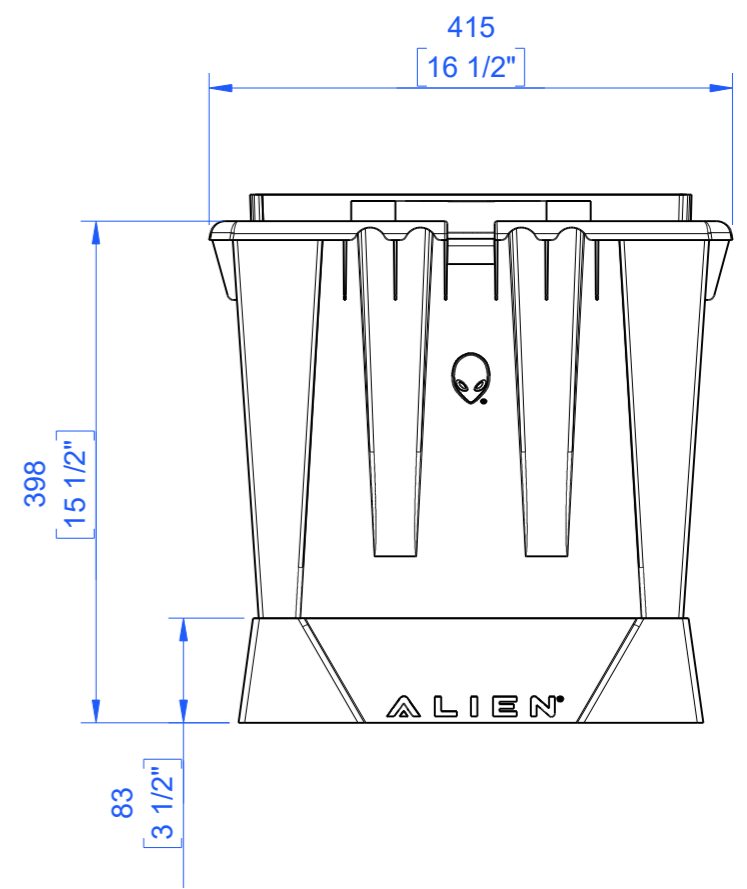
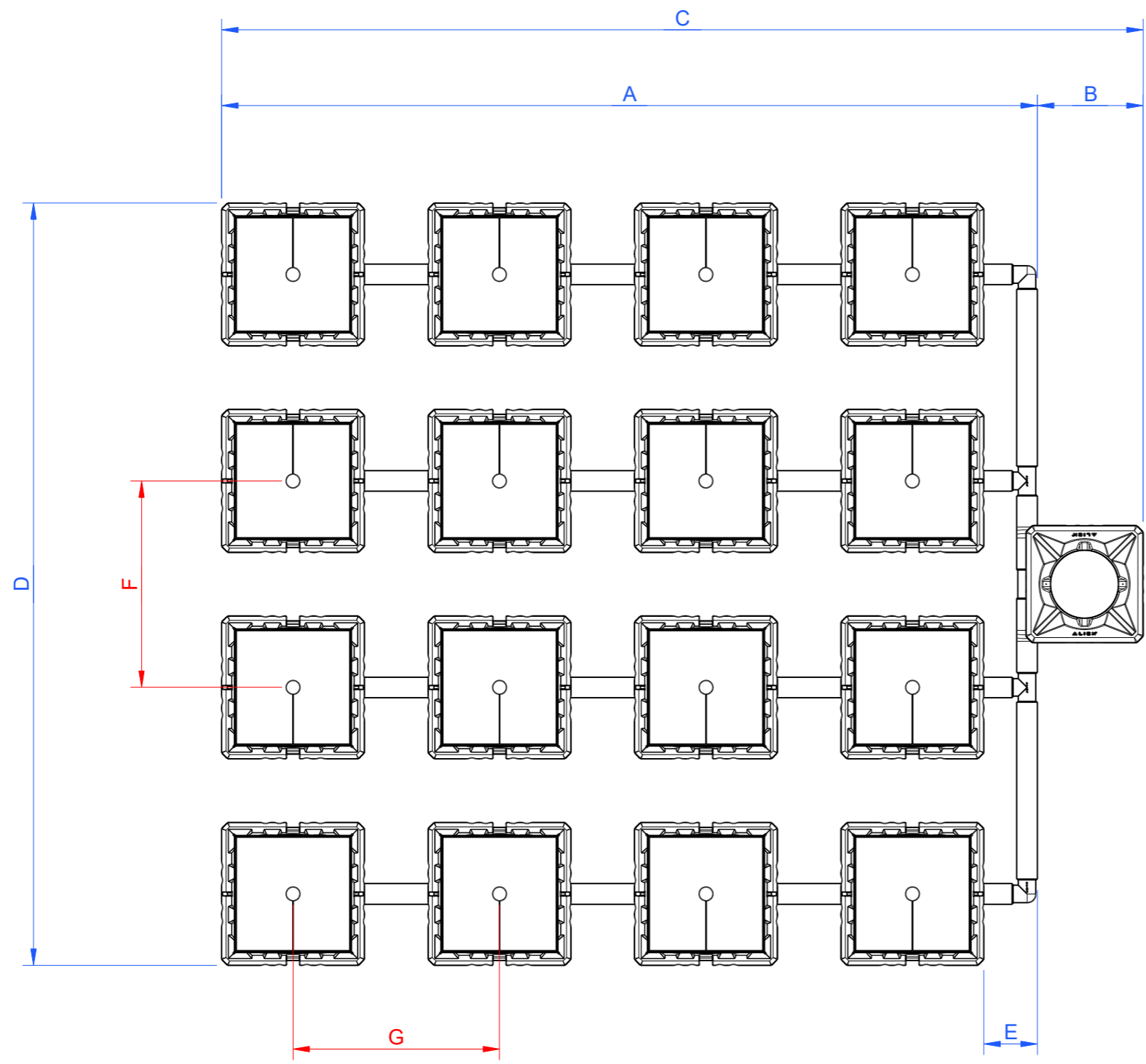

Water Pumps	Litres to Flood**	Recommended Tank Size
2 x JET-60W 3200 L/hr	228L	550L

Dimensions	Min (mm)	Min (inches)	Maximum (mm) @ 75cm Plant Centres*	Maximum (inches)
A	1697	67"	3235	127"
B	309	12"	309	12"
C	2006	79"	3544	140"
D	1663	65"	2665	105"
E	1643	1"	570	22"
F	416	16"	750	30"
G	416	16"	750	30"

**Notes:**  
 \* Plant centres greater than 75cm are possible with extra pipe. Please contact [tech@alienhydroponics.co.uk](mailto:tech@alienhydroponics.co.uk) (Uk and Europe) or [sales@alienhydro.com](mailto:sales@alienhydro.com) (USA) for more details.

\*\* Calculated with medium in pots.

	Project: Flood and Drain 2025	Scale 1 : 16
	Title: <b>30L 4 Row 16 Pot</b>	
	Drawing Number: <b>FD30-4.16</b>	Sheet 1 of 1