

Rev	Date
A	12 / 12 / 2024

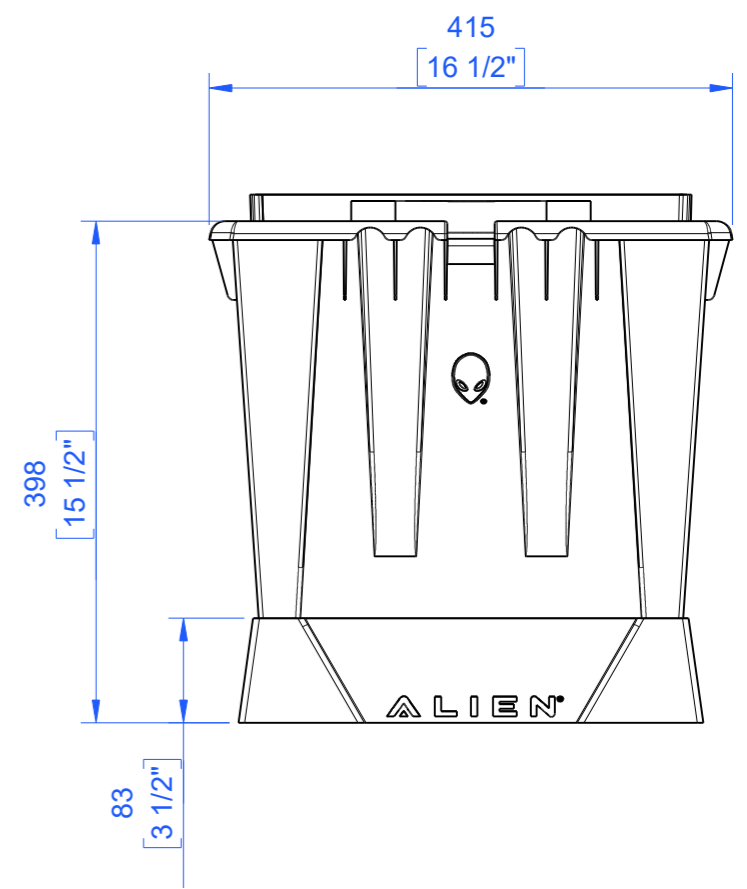
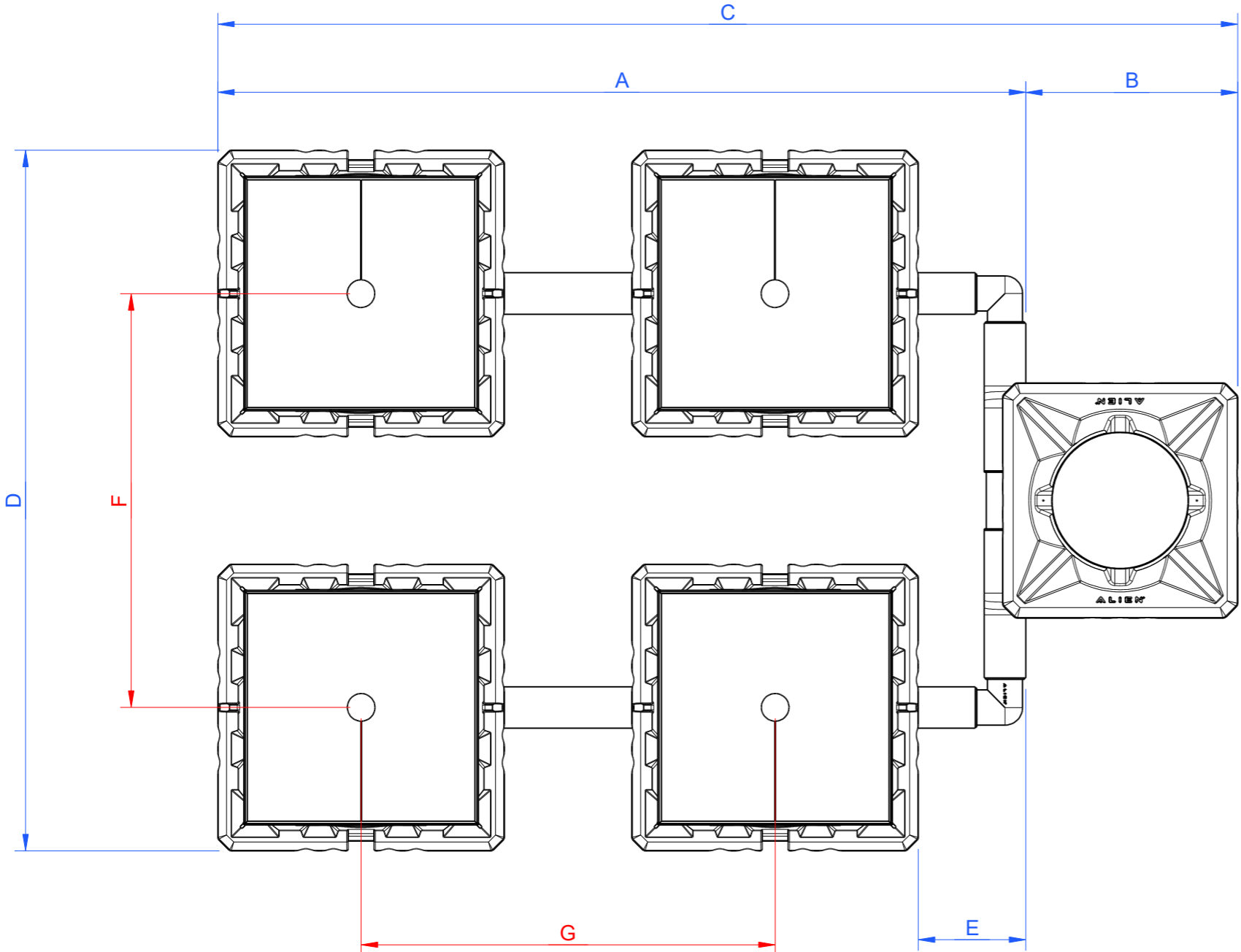

Water Pumps	Litres to Flood**	Recommended Tank Size
2 x JET-60W 3200 L/hr	72L	280L

Dimensions	Min (mm)	Min (inches)	Maximum (mm) @ 75cm Plant Centres*	Maximum (inches)
A	865	34"	1735	68"
B	309	12"	309	12"
C	1174	46"	2044	80"
D	831	33"	1165	46"
E	34	1"	570	22"
F	416	16"	750	30"
G	416	16"	750	30"

Notes:
 * Plant centres greater than 75cm are possible with extra pipe. Please contact tech@alienhydroincs.co.uk (Uk and Europe) or sales@alienhydro.com (USA) for more details.

** Calculated with medium in pots.

	Project: Flood and Drain 2025	Scale 1 : 8
	Title: 30L 2 Row 4 Pot	
	Drawing Number: FD30-2.4	Sheet 1 of 1