

Rev	Date
A	06 / 01 / 2025

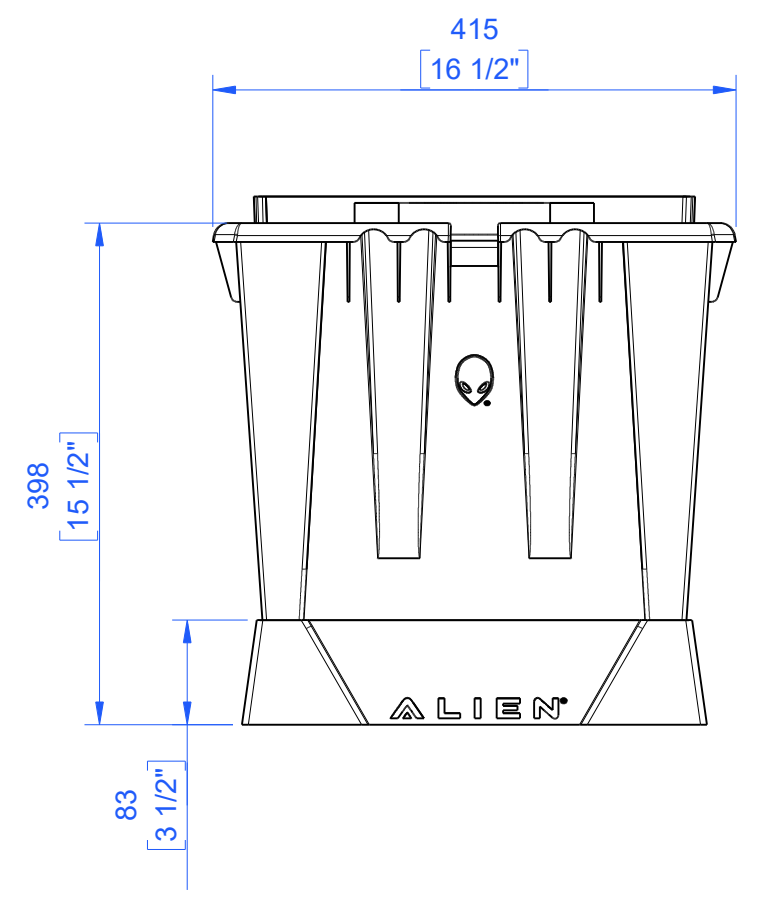
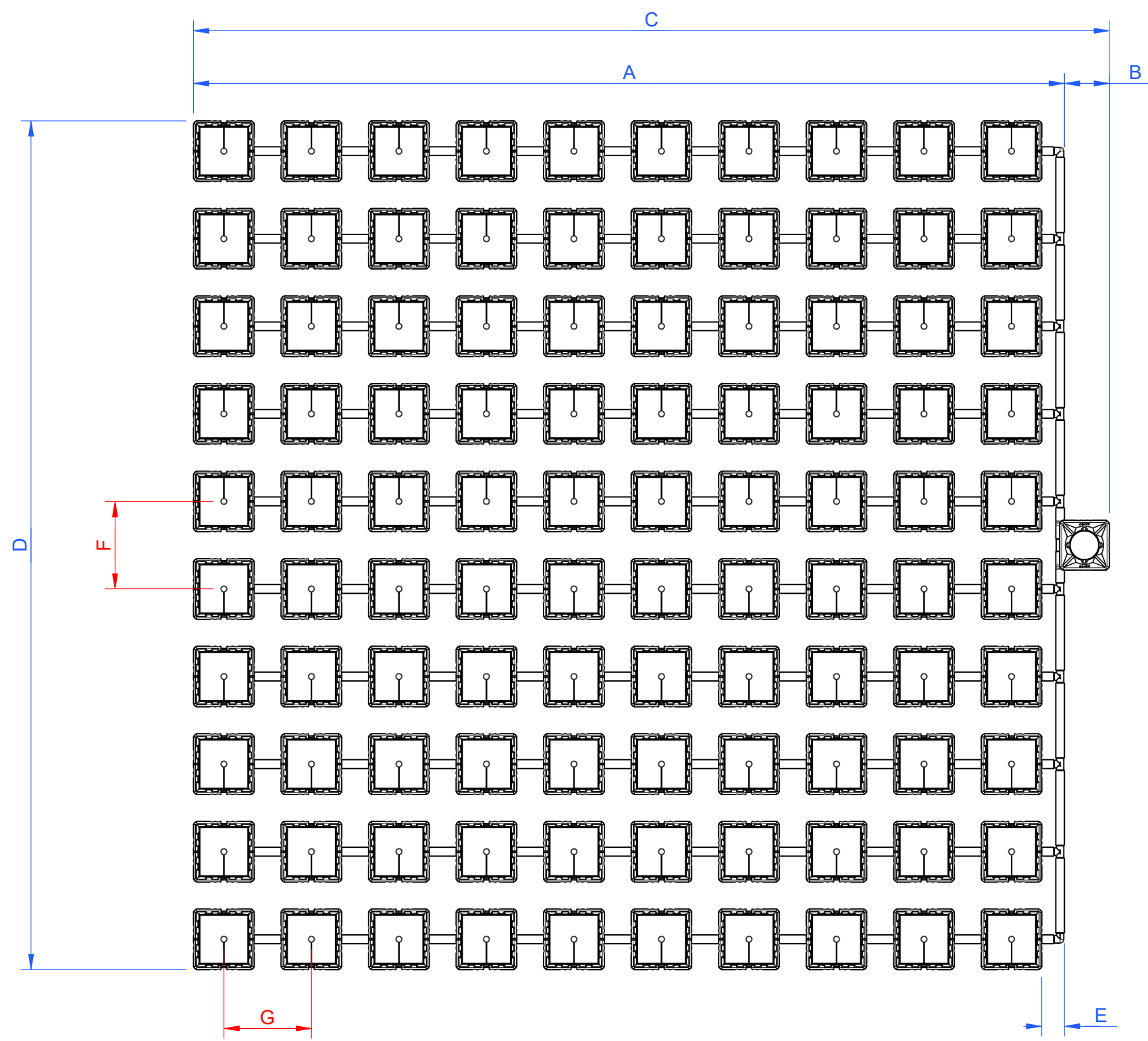

Water Pumps	Litres to Flood**	Recommended Tank Size
4 x JET-60W 3200 L/hr	1330L	780L x 3

Dimensions	Min (mm)	Min (inches)	Maximum (mm) @ 75cm Plant Centres*	Maximum (inches)
A	4193	165"	7735	305"
B	309	12"	309	12"
C	4502	177"	8044	317"
D	4159	164"	7165	282"
E	34	1"	570	22"
F	416	16"	750	30"
G	416	16"	750	30"

Notes:
 * Plant centres greater than 75cm are possible with extra pipe. Please contact tech@alienhydroponics.co.uk (Uk and Europe) or sales@alienhydro.com (USA) for more details.

** Calculated with medium in pots.

	Project: Flood and Drain 2025	Scale 1 : 35
	Title: 30L 10 Row 100 Pot	
	Drawing Number: FD30-10.100	Sheet 1 of 1