

Rev	Date
A	10 / 12 / 2024

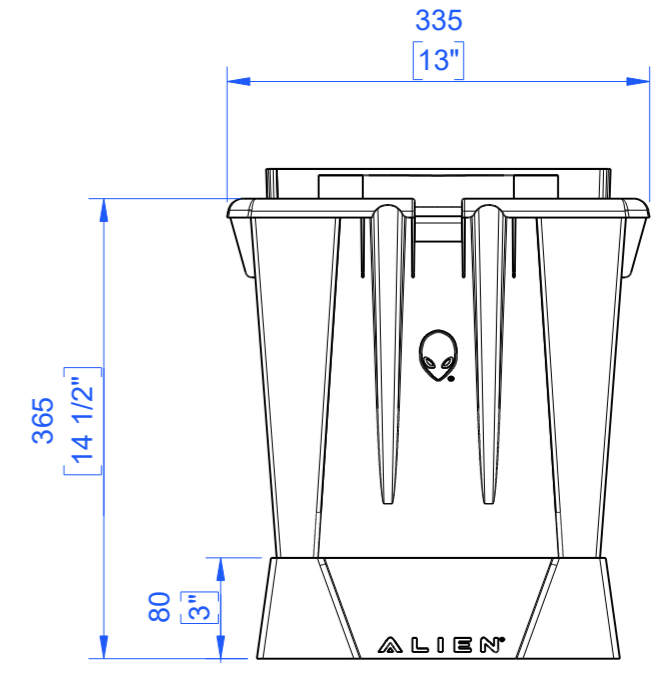
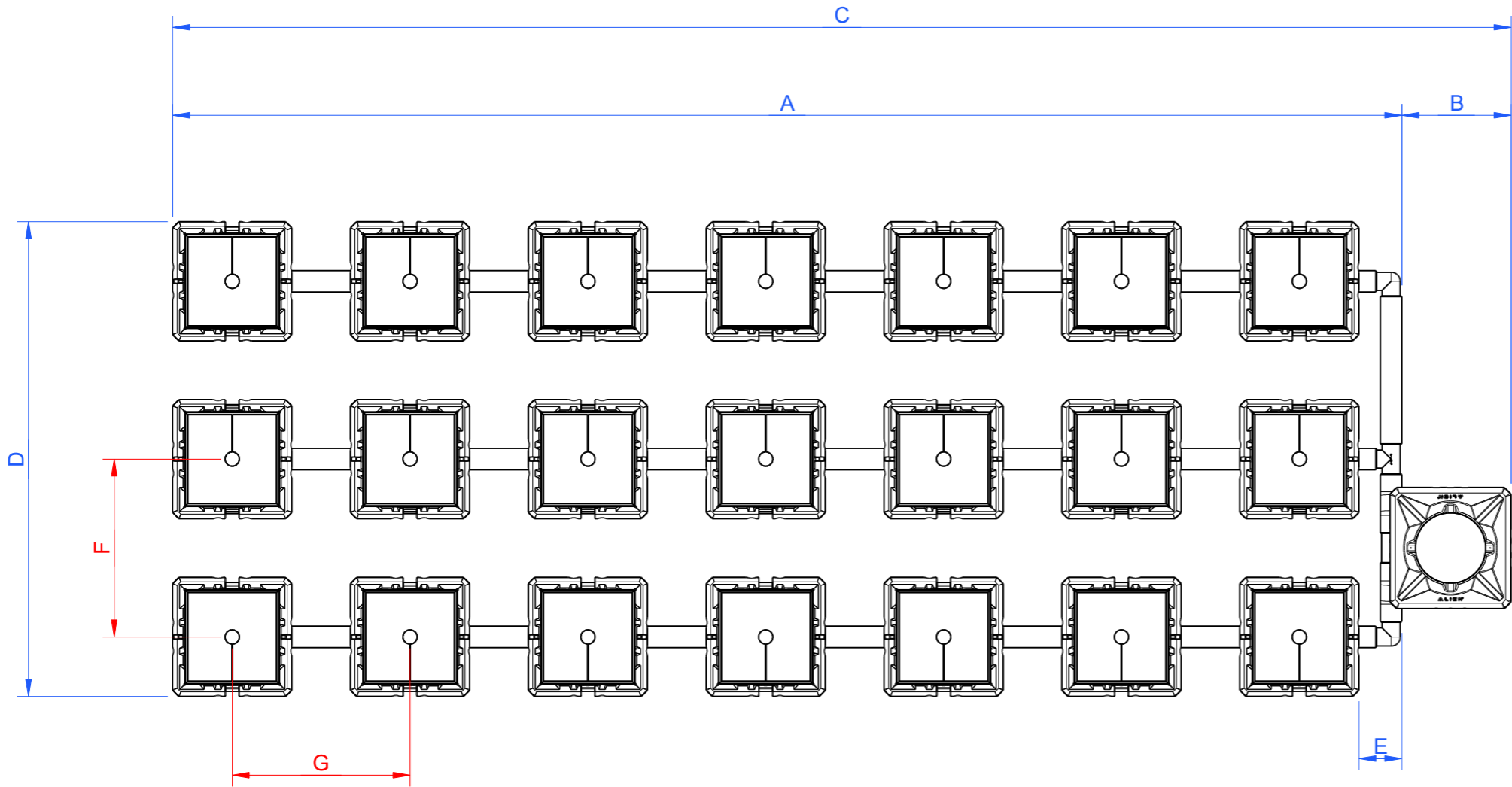

Water Pumps	Litres to Flood**	Recommended Tank Size
2 x JET-105W 4500 L/hr	167L	550L

Dimensions	Min (mm)	Min (inches)	Maximum (mm) @ 60cm Plant Centres*	Maximum (inches)
A	2406	95"	4312	170"
B	309	12"	309	12"
C	2715	107"	4621	182"
D	1047	41"	1535	60"
E	49	2"	377	15"
F	375	15"	600	24"
G	337	13"	600	24"

Notes:
 * Plant centres greater than 60cm are possible with extra pipe. Please contact tech@alienhydroincs.co.uk (Uk and Europe) or sales@alienhydro.com (USA) for more details.

** Calculated with medium in pots.

	Project: Flood and Drain 2025	Scale 1 : 16
	Title: 15L 3 Row 21 Pot	
	Drawing Number: FD15-3.21	Sheet 1 of 1