

Rev	Date
A	10 / 12 / 2024

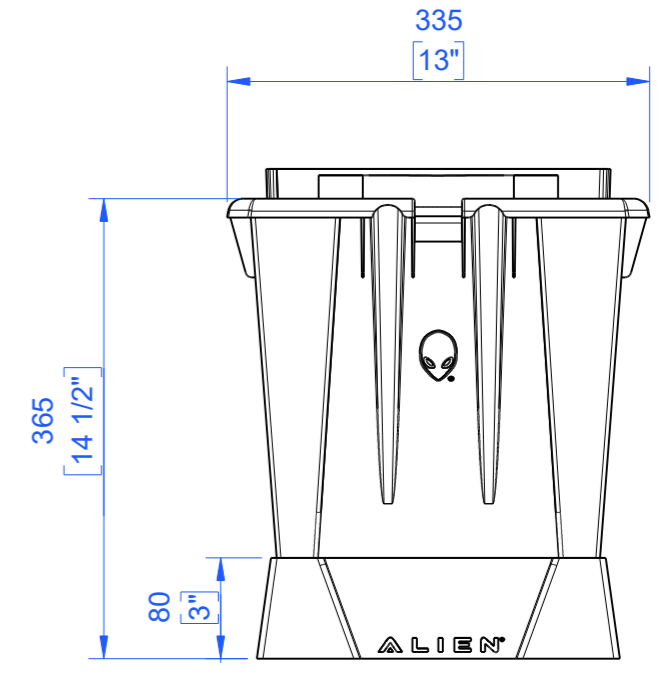
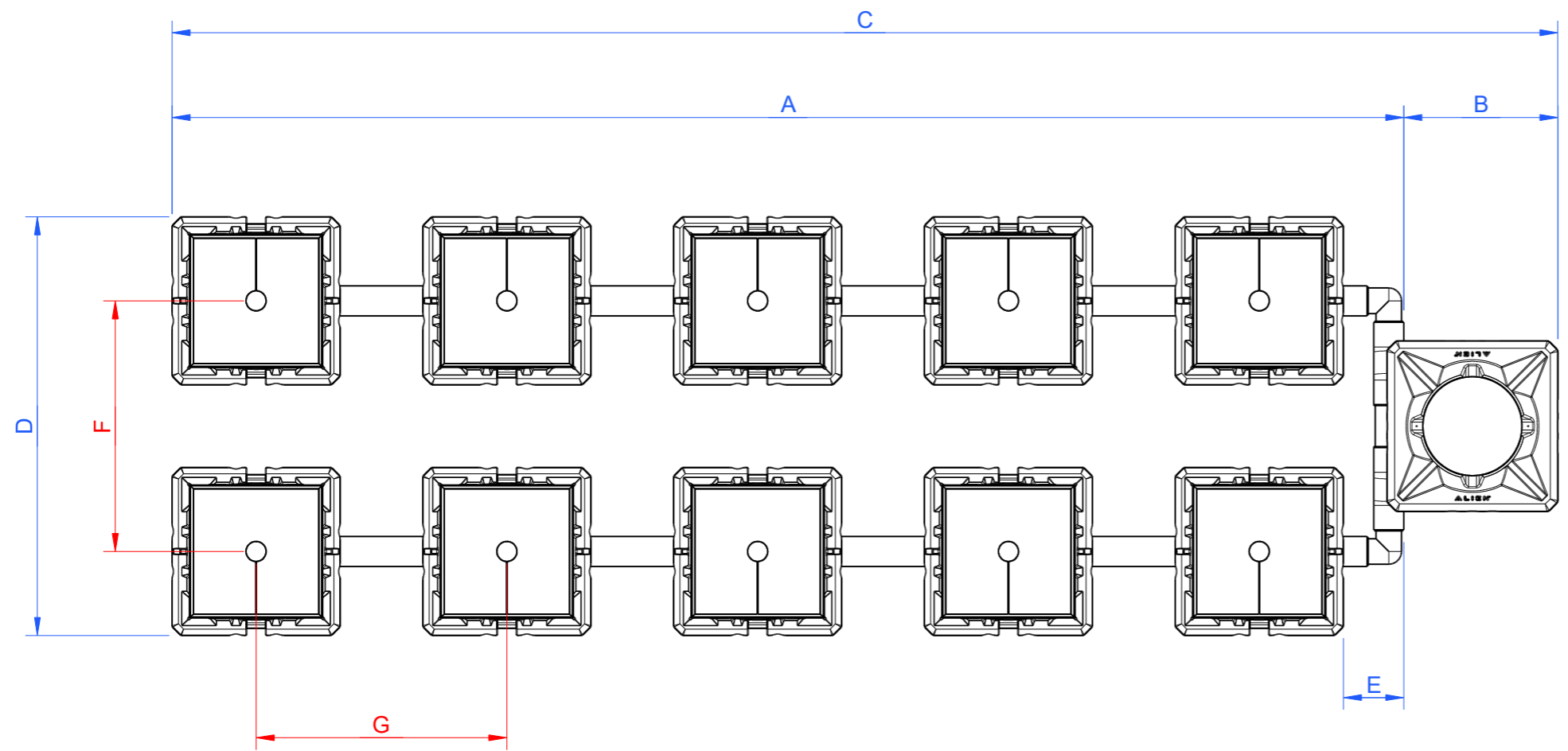

Water Pumps	Litres to Flood**	Recommended Tank Size
2 x JET-60W 3200 L/hr	90L	280L

Dimensions	Min (mm)	Min (inches)	Maximum (mm) @ 60cm Plant Centres*	Maximum (inches)
A	1732	68"	3112	123"
B	309	12"	309	12"
C	2041	80"	3421	135"
D	710	28"	935	37"
E	49	2"	377	15"
F	375	15"	600	24"
G	337	13"	600	24"

Notes:
 * Plant centres greater than 60cm are possible with extra pipe. Please contact tech@alienhydroincs.co.uk (Uk and Europe) or sales@alienhydro.com (USA) for more details.
 ** Calculated with medium in pots.

	Project: Flood and Drain 2025	Scale 1 : 12
	Title: 15L 2 Row 10 Pot	
	Drawing Number: FD15-2.10	Sheet 1 of 1