

Rev	Date
A	10 / 12 / 2024

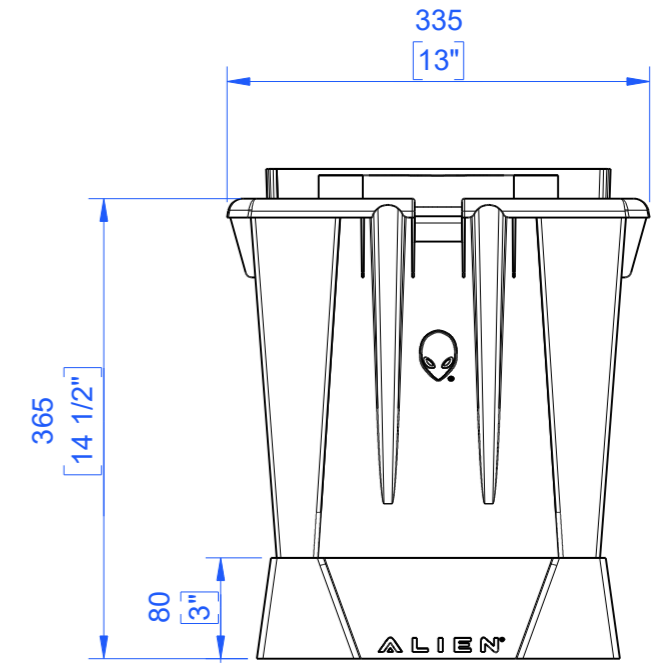
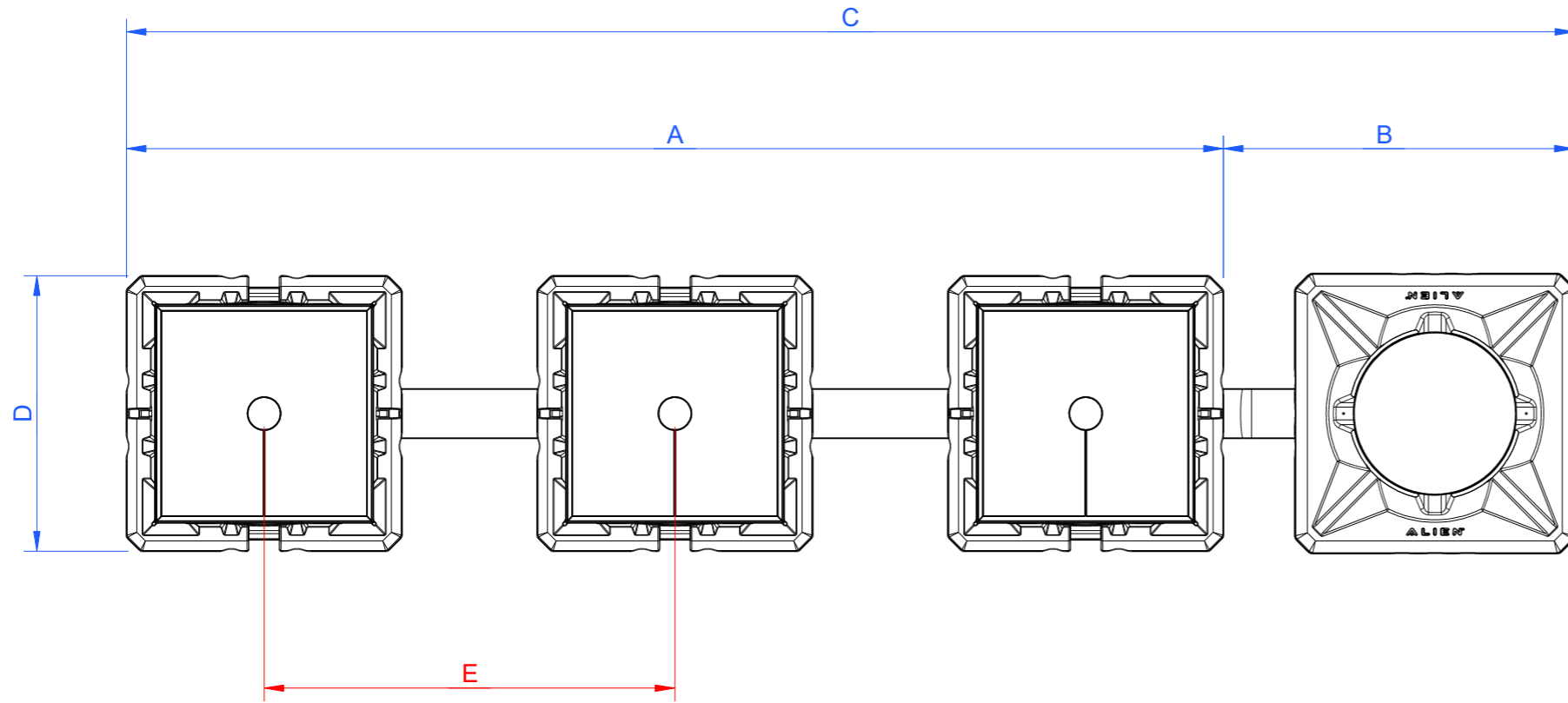

Water Pumps	Litres to Flood**	Recommended Tank Size
2 x JET-60W 3200 L/hr	41L	120L

Dimensions	Min (mm)	Min (inches)	Maximum (mm) @ 60cm Plant Centres*	Maximum (inches)
<b>A</b>	1009	40"	1535	60"
<b>B</b>	337	13"	677	27"
<b>C</b>	1346	53"	2212	87"
<b>D</b>	335	13"	335	13"
<b>E</b>	337	13"	600	24"

**Notes:**  
 \* Plant centres greater than 60cm are possible with extra pipe. Please contact [tech@alienhydroincs.co.uk](mailto:tech@alienhydroincs.co.uk) (Uk and Europe) or [sales@alienhydro.com](mailto:sales@alienhydro.com) (USA) for more details.

\*\* Calculated with medium in pots.

	Project: Flood and Drain 2025	Scale 1 : 8
	Title: <b>15L 1 Row 3 Pot</b>	
	Drawing Number: <b>FD15-1.3</b>	Sheet 1 of 1